

Anybus®

BY HMS NETWORKS

Gateway and Wireless solutions



Anybus X-gateway
Anybus Communicator
Anybus Wireless Bolt
Anybus Wireless Bridge



Hms Connecting Devices™

Anybus Gateways

Industrial networking made easy™

Connecting devices to any fieldbus, industrial Ethernet and IoT platform

Let's face it. Network connectivity is an absolute jungle. Staying up-to-date with fieldbuses, industrial Ethernet networks and IoT platforms is time-consuming and resource-demanding. Luckily, Anybus gateways offer quick and easy system integration by acting as translators between industrial networks and industrial devices — wired or wirelessly.

With more than 300 unique versions to choose from, Anybus gateways solve any type of connectivity problem, whether it is a network-to-network or device-to-network situation.

Why Anybus?

Proven and trusted

Millions of devices are connected to fieldbus and industrial Ethernet networks via Anybus technology in the format of gateways or embedded interfaces.

Anybus gateways have successfully connected devices, machines and networks for more than 20 years, opening up new applications and business possibilities for industrial companies in all areas.

With Anybus gateways best-in-class connectivity is provided to PLC systems from leading vendors such as Rockwell Automation, Siemens, Schneider Electric, Mitsubishi and more.

Quick and easy

Using Anybus gateways is by far the quickest way to achieve connectivity between networks and devices. All gateways include fully implemented fieldbus and industrial Ethernet interfaces, making them ready to connect your equipment to any desired network.

Furthermore, innovative Anybus Wireless solutions also add to the networking flexibility, enabling completely new industrial networking architectures.

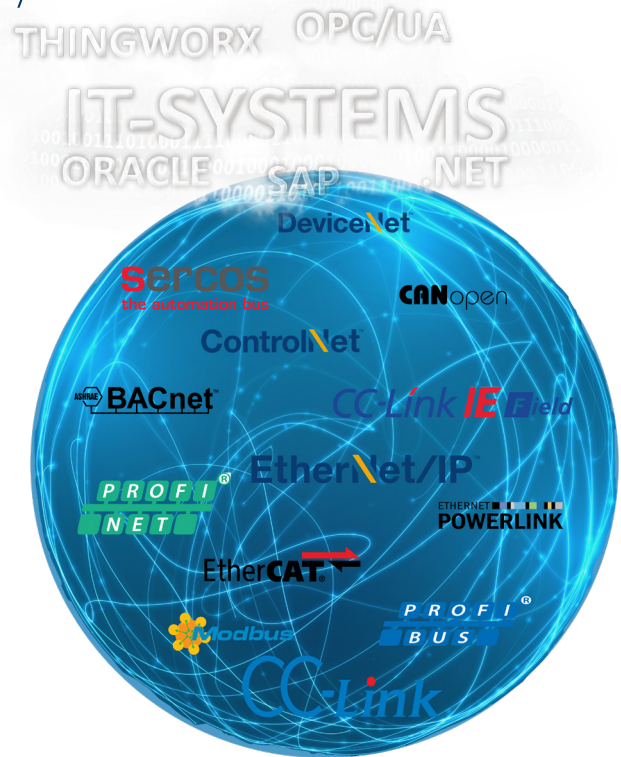

Connect. Configure. Done!

With Anybus, you can connect between industrial devices and networks within minutes

Wireless Technical Services

Let Anybus wireless experts help you in your project

The HMS Technical Services Team is here to help you make the most out of your HMS products. We offer technical assistance, training and consulting to help projects move forward efficiently and successfully, from idea to fully implemented and deployed solutions. This saves time and money and increase quality of the project.



Anybus Wireless Infrastructure Solution Assistance

This service will help you to get a quick start at understanding functionality and configuration of the wireless and infrastructure products. The service covers:

- Suggest products, based on the application, useful functionality and how to combine.
- Recommend wireless technology to use.
- Recommend solutions for security and redundancy.
- Recommendation of tools and documentation that will reduce configuration time
- Guidance in configuration and installation

Time and location: Charged / hour via Phone, Teams, Zoom or in Halmstad.

ORDERCODE: SA1250



Anybus Wireless & Infrastructure Implementation Assistance

This service speeds up design and implementation using Anybus products. It includes:

- Assistance with configurations, based on intended design and application.
- Application review and review of communication logs.
- Guidance on best practice regarding settings, timers etc.
- Guidance on wireless installation and predictive site survey.

Time and location: Halmstad or at customer. Charged / hour.

ORDERCODE: SA1251



Application Verification/Trouble-shooting Assistance

This service gives important feedback of the application design in order to verify the hardware and software implementation. Equipment from other vendors can be brought or shipped to HMS. This can reduce development time and cost as well as improve the solution to interface correctly with different networks and PLC systems.

- Connect the complete solution as far as possible. PLCs from major vendors available to verify correct behaviours.
- Verify performance
- Give feedback on important things like data-rates, timer setting.

Time and location: Halmstad. Charged / Day. Preferably at HMS in Halmstad as there are several types PLCs available.

ORDERCODE: SA1252

Anybus Gateways

Solving connectivity problems on the factory floor

Extend a production line

Extend an existing production segment by connecting new machines that communicate on other networks.

Upgrade to industrial Ethernet

The easy way to migrate from fieldbus to industrial Ethernet. Retrofit an old PLC system, and connect it to a newer system, keeping existing I/O modules and wiring infrastructure.

Make PLCs talk

Connect two PLC systems from different brands such as Siemens, Rockwell, Schneider Electric, Mitsubishi, Beckhoff, ABB etc. Anybus gateways are included in most of the major PLC manufacturers' system building software, making it easy for you to integrate them into your network design.

Create network segments

Divide a network topology into logical segments. Create clear cuts between different parts of the plant, both logical and electrical.

Connect building equipment

Connect building devices such as sensors, temp meters, or HVAC systems to an industrial network system. Achieve a fully integrated communication solution for your site. HVAC gateways are provided by Intesis (member of the HMS group).

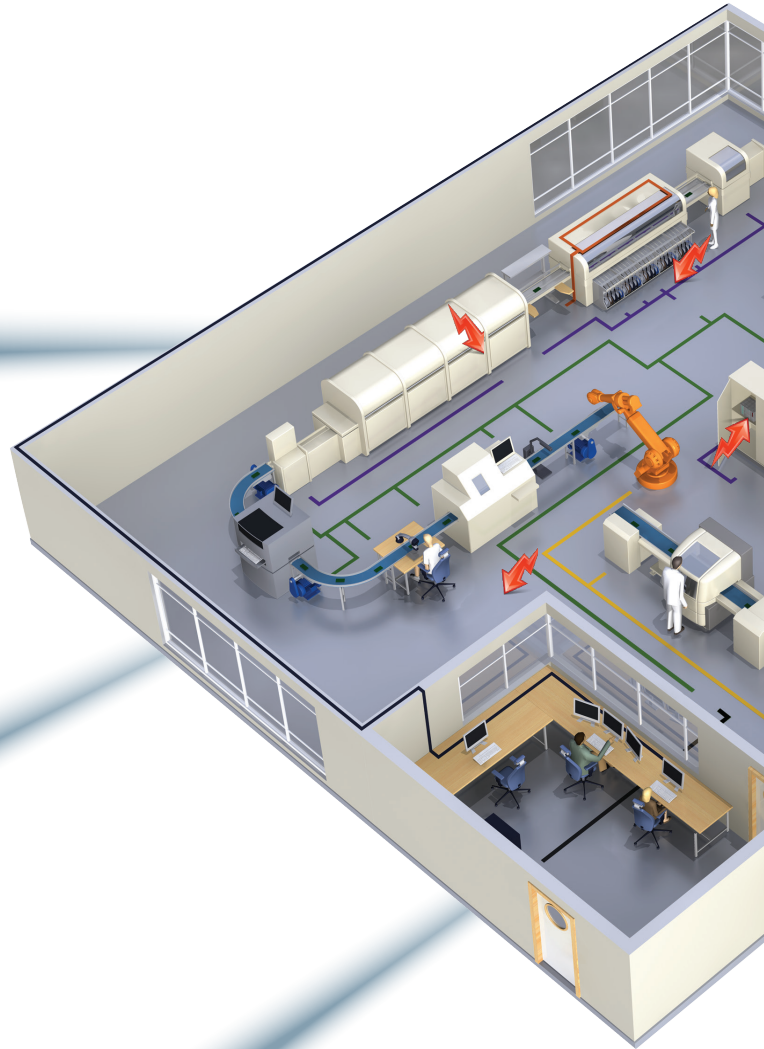



THINGWORX OPC/UA
IT-SYSTEMS
ORACLE SAP NET



Connect to IoT platforms

Proven and secure solutions to integrate factory floor data with IT technologies and protocols such as OPC UA and MQTT and IoT systems such as ThingWorx, Microsoft Azure, etc.

Connect any device to networks

Connect serial or CAN-based devices to fieldbus or industrial Ethernet networks.



System integrators can retrofit and connect existing machinery to new networks and choose the best automation device for your needs, regardless of manufacturer.

Machine builders and device manufacturers can make their products compatible with any network — the fastest and easiest way to leverage new market opportunities.



Connect devices wirelessly

Create a robust wireless connection to an industrial device, machine or system via WLAN or Bluetooth. Ideal for communication through hazardous areas or hard-to-reach locations where cables are not desirable.



Bring your own device (BYOD)

Create innovative BYOD and IIoT solutions by connecting machines wirelessly. Use your laptop or smartphone as an alternative to an HMI. A perfect solution for data acquisition and monitoring.

Temperature
work or IT
on
ded by

Anybus Communicator Connect - Configure - Done!

"No matter which gateway you choose, you configure the network connection in the easy-to-use Graphical User Interface from HMS, simply connect the Communicator, create the configuration and you are done."

Fredrik Brynolf
Product Manager OT Gateways, Anybus





Anybus Communicator



Connect any device to a fieldbus or industrial Ethernet network

Anybus® Communicator™ is a family of protocol converters that connect devices to all major industrial networks. The Communicator is capable of converting almost any standard or user specific and proprietary protocol. This means that you do not have to worry about making any hardware or software changes to your device. Simply connect a Communicator and you will be able to connect to any network.

Easy configuration

The device connection is configured using the easy to use Anybus Configuration Manager software. Just connect, configure, and you're done.



Communicator Serial RS232/422/485

- Protocol converters with flexible serial frame building
- Connectivity to 13 networks
- Supports Modbus RTU/DF1/ASCII or vendor-specific protocols
- For Request/Response or Produce/Consume protocols

Communicator CAN

- Protocol converters with flexible CAN frame building
- Connectivity to 11 networks
- For devices with CAN 2.0A and 2.0B based protocols

Example: Single and multi-drop connectivity to DeviceNet

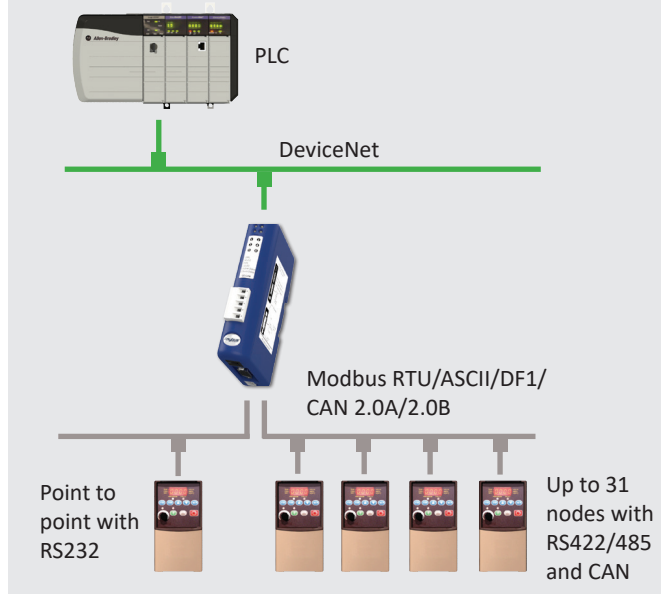

Mounting	DIN rail (35 x 7,5/15)	
Dimensions	120 x 75 x 27 mm	
Protection class	IP20	
Configuration	Windows-based configuration manager	
Material	Plastic	
Versions	Communicator Serial: CANopen CC-Link CC-Link IE Field ControlNet DeviceNet EtherCAT EtherNet/IP FIPIO Interbus Modbus Plus Modbus RTU Modbus TCP PROFIBUS PROFINET IO PROFINET IRT	Communicator CAN: CANopen CC-Link ControlNet DeviceNet EtherCAT EtherNet/IP Modbus RTU Modbus-TCP PROFIBUS PROFINET-IO 1-port PROFINET-IRT 2-port



Anybus Communicator

Connect any device to an industrial Ethernet network or Profibus

The new generation



Anybus® Communicators provide an even better and easier way to connect your device to the major industrial Ethernet networks as well as Profibus. These products will co-exist with the Communicator Classic offer in order to give access to the latest Greenfield installations, as well as existing Brownfield systems.

Easy configuration

The set-up and configuration of the Communicator is easily done by using the Graphical user interface provided by HMS. Simply connect the Communicator, create the configuration and you are done!





Powerful

-  1500 bytes I/O data
-  Industrial temp range
-  Latest security technology



Time saver

-  Ethernet config port
-  Web user interface
-  Graphical user interface

Mounting	DIN rail (35 * 7,5/15)
Dimensions	98 x 27 x 144 mm 3.85 x 1.06 x 5,67 in
Protection class	IP20
Configuration	Web based configuration
Material	PC ABS, UL 94 VO
Versions	Modbus TCP, EtherNet/IP, Profinet - Profibus available in Q3-21

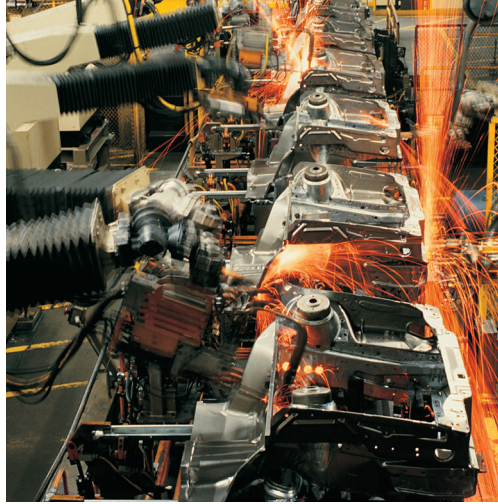

Anybus X-gateway

Connect any two industrial networks
– fieldbus or industrial Ethernet

Anybus® X-gateways™ help you to easily connect any two networks, enabling a consistent information flow throughout the entire plant. A fast transfer of cyclic I/O data is enabled between the two networks, offloading the PLC from working with additional complex calculations.

The X-gateways are tested and proven with equipment from all leading manufacturers of PLCs such as Siemens, Allen Bradley, Schneider Electric, Mitsubishi, ABB, Omron, Hitachi, Beckhoff, Phoenix Contact, Bosch Rexroth and more.

Easy configuration

The connection between the two networks is quickly configured using the Anybus Configuration Manager software, which means that no programming is required. Just connect, configure, and you're done.

Anybus X-gateway

- Gateways for conversion between any two networks
- Over 250 versions covering most network combinations
- Easy configuration via the Anybus Configuration Manager
- Master/slave or slave/slave versions available



Mounting	DIN rail (35 x 7,5/15)
Dimensions	114 x 44 x 127 mm
Protection class	IP20
Configuration	Windows-based configuration manager
Material	Aluminium and plastic
Master versions	AS-Interface DeviceNet EtherNet/IP PROFIBUS Modbus-TCP CANopen
Slave versions	CANopen CC-Link CC-Link IE Field ControlNet DeviceNet EtherCAT EtherNet/IP FIPIO Interbus RS485 + Fiber Optic J1939 LonWorks Modbus Plus Modbus RTU Modbus-TCP PROFIBUS PROFINET IO PROFINET IRT Copper + Fiber Optic



Example: PLC to PLC communication (slave/slave gateway)

Modbus-TCP to PROFINET

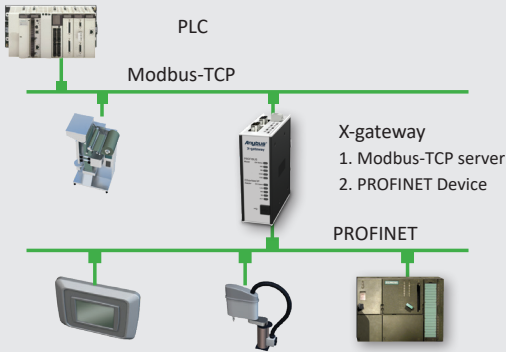

Example: Distributed network master (master/slave gateway)

EtherNet/IP to PROFIBUS

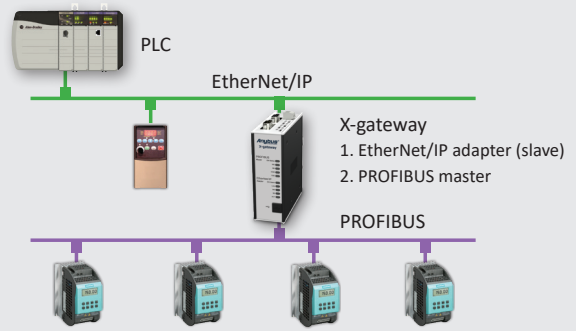

Specialized gateways



CANopen
Specialized X-gateway for CANopen connectivity. Acts as CANopen master/client to 10 other networks.



Modbus-TCP
Specialized X-gateway for Modbus-TCP connectivity. Acts as Modbus-TCP master/client to 10 other networks.



EtherNet/IP Linking Devices
Connect any PROFIBUS, Modbus-TCP or serial device/network to ControlLogix™ and CompactLogix™ PLCs from Rockwell Automation. The Linking Devices are stand-alone gateways offering seamless integration to Studio5000 via EtherNet/IP.



Modbus to KNX or BACnet
Allows building devices such as sensors, temperature meters, or HVAC systems to communicate on a Modbus network.



Modbus RTU to TCP
Allows Modbus RTU devices to communicate on a Modbus TCP network.



Anybus Wireless Bridge

Replace CAN, Serial or Ethernet cabling with a robust wireless connection

Anybus® Wireless Bridge™ is ideal for system integrators needing to establish a robust wireless connection for industrial use. The Wireless Bridge is often used in pairs but can also be used as an access point connecting up to 7 clients.

Range:	Up to 400 meters
Mounting:	DIN-rail or wall-mounted
IP class:	IP65
Configuration:	Push-button or web based
Connectors:	M12 (DSUB on serial version)
Wired:	Ethernet, Serial or CAN
Wireless:	Bluetooth or Wi-Fi

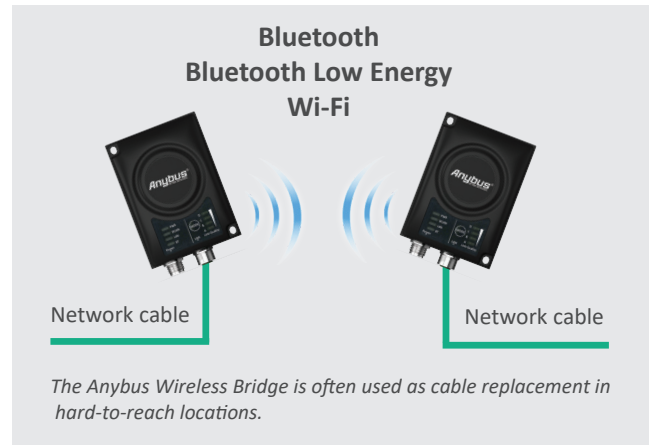

Coming product autumn 2021:
Serial and CAN communication over
Bluetooth/Wi-Fi, point to point or
Multipoint

**Anybus Wireless Bolt and Bridge for industrial applications:
Go wireless!**

"The Anybus Wireless family is constantly growing, now offering a wide variety of connectivity alternatives depending on your application."

Martin Falkman, Product Manager



**Ethernet over
Bluetooth and Wi-Fi**
Point-to-point or multipoint



Bridge and Bolt work



Anybus Wireless Bolt

Enable wireless machine access

Anybus® Wireless Bolt™ is ideal for machine builders wanting to give their machines wireless access. It is mounted onto a cabinet or a machine and connects using Ethernet, CAN or Serial communication. There are numerous of different possibilities to use the Wireless Bolt depending on your application/needs.

- Range:** Up to 100 meters
- Mounting:** Screwed onto machine (M50 hole — 50.5 mm)
- IP class:** IP67 outside (IP21 inside)
- Configuration:** Web based, AT Commands or Easy Config modes
- Connector:** 2x9p;3,5 Plug Connector or RJ45 connector with PoE
- Wired:** Ethernet, Serial RS232/485 and CAN
- Wireless:** Bluetooth, Bluetooth Low Energy or Wi-Fi, Cellular LTE with NB-IoT or CAT-M1

Bluetooth
Bluetooth Low Energy
Wi-Fi
NB - IoT
CAT - M1



The Anybus Wireless Bolt enables wireless connectivity to a machine or a cabinet and is ideal for data acquisition. Connect with your Phone/Tablet/Laptop, this means that you no longer need an expensive HMI.



together seamlessly



Anybus Wireless Bolt Serial
Modbus TCP to RTU



Anybus Wireless Bolt IoT
LTE standards: NB- IoT and CAT- M1



Anybus Wireless Bolt CAN



Anybus Wireless Bolt - RJ45 PoE

All Bolts are available with Black top White top for sunny outdoor installations.



Work with HMS.
The number one choice for
Industrial ICT - Information and
Communication Technology.

HMS Networks - Contact

HMS is represented all over the world.
Find your nearest contact here:

www.hms-networks.com/contact

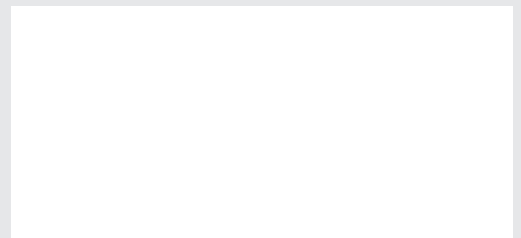

Anybus® is a registered trademark of HMS Industrial Networks AB, Sweden, USA, Germany and other countries. Other marks and words belong to their respective companies. All other product or service names mentioned in this document are trademarks of their respective companies.
Part No: MMA100 Version 10 06/2021 - © HMS Industrial Networks - All rights reserved - HMS reserves the right to make modifications without prior notice.



www.anybus.com